

ROADS OR RADAR: INVESTING IN INFRASTRUCTURE OR IMPROVED FORECASTING IN THE FACE OF TROPICAL CYCLONE RISK

12B.7

SEONG DAE KIM * AND J. ERIC BICKEL
TEXAS A&M UNIVERSITY, COLLEGE STATION, TEXAS

1. INTRODUCTION

Even with the advanced technology of forecasting and current infrastructure to mitigate the loss from natural hazards, people suffer from devastating hurricanes every year. Although Nature or a natural system creates such storms, humans can still forecast and respond to them. A forecasting system predicts the natural system, and a transportation system reacts to it. The interactions of these human systems with each other and with the natural system are illustrated in Fig. 1. A government official or other decision maker (DM) who is in charge of the response to emergencies has to decide the relative amounts to invest in a forecasting system, the transportation system, or infrastructure for protection from the natural hazard.

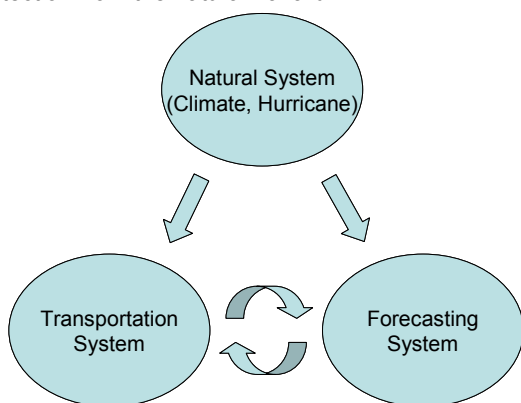

Fig. 1. Roads Radar system

Investing all available resources in the improvement of forecast accuracy may not be optimal, nor may doing likewise for an evacuation system. Investing in a mix of the two strategies is more likely to minimize diminishing returns. Determining an optimal mix entails understanding the interplay between a transportation system and a forecasting system.

We use dynamic programming (DP) to model this multi-stage hurricane-evacuation decision problem and a Markov Chain to model the revision of a DM's belief about strike probability and landfall intensity.

2. LITERATURE REVIEW

This work has links to several areas, including dynamic programming, dynamic decision-making, Bayesian updating, Markov Chain process, and cost-loss ratio.

Dynamic programming has been applied to decision problems where the sequential decision process enters a state that governs the system's behavior until it leaves that state. Without dynamic programming, such decision problems can be computationally infeasible. Howard (1966) showed that dynamic programming based on the Markov process has application in a wide variety of situations, including maintenance and repair, financial portfolio balancing, inventory and production control, equipment replacement, and directed marketing.

If the decision involves not only selection among alternatives but also determination of timing, a static decision model is inadequate. Ahn and Kim (1998) formulated the action-timing problem with Bayesian updating and derived decision rules based on the observation or information. They used sequential Bayesian revision for the action-timing problem and demonstrated its value using simulation. Their work provides a decision rule based on the information or observation at each stage, rather than on the revised belief. They consider only two alternatives: "accept" the current observation or "reject" in favor of another observation.

There have been many studies about the value of improving forecast accuracy. Murphy and Ehrendorfer (1987) explored the relationship between the quality and value of imperfect forecasts. They used the Brier score as a measure of forecast accuracy, but they found that a scalar measure such as the Brier score cannot completely and unambiguously characterize the quality of the imperfect forecasts. Their research showed the relationship between forecast accuracy and forecast value represented by a multi-valued function—an accuracy/value envelope.

Mjelde et al. (1993) used a structure called a "forecast matrix" to represent various scenarios for climate forecast quality. A stochastic dynamic programming model was used to obtain the expected value of the various scenarios. They attempted to quantify forecast quality through two measures: entropy and variance of the forecast. They showed that the entire structure of the forecast format interacts to determine the economic value of that system.

Considine et al. (2004) examined the value of hurricane forecasts to oil and gas producers rather than the general population. Unlike the general population, the producers of crude oil and natural gas in the Gulf of Mexico respond to the threat of hurricanes by evacuating offshore drilling rigs and temporarily ceasing production. The researchers estimated the value of existing as well as more accurate hurricane forecast

information to show the value of improving forecast accuracy. They used a probabilistic cost-loss model to estimate the incremental value of hurricane forecast information for oil and gas leases in that area over the past two decades. Their research showed that forecast value dramatically increases with improvements in accuracy. They simulated a 50% improvement in 48-hr forecast accuracy, which they assumed would double the strike probability given a strike forecast, to 0.60. They used a critical threshold of the forecast of weather conditions important to the rig operator at the drilling location, such as wind speed and wave height, to distinguish a strike forecast from a no-hit forecast.

Regnier and Harr (2006) deal with the decision to prepare for an oncoming hurricane using a discrete Markov model of hurricane travel that is derived from historical tropical cyclone tracks and combined with the dynamic decision model to estimate the additional value that can be extracted from existing forecasts by anticipating updated forecasts. They used variable hurricane preparation cost, which is defined as a fraction of the maximum loss, increasing linearly or exponentially after a critical lead-time. They used a discrete Markov model for multi-period decision making with respect to a sequence of more than two forecasts with improving accuracy for a single event. Simulation was used to compare the expense in different cases.

Czajkowski (2007) developed a dynamic model of hurricane evacuation behavior in which a household's evacuation decision is framed as an optimal stopping problem where every potential evacuation time prior to the actual hurricane landfall presents the household with the choice either to evacuate or to wait one more period for a revised hurricane forecast. Czajkowski used a Markov Chain to represent the revision of hurricane status and used a state variable named "risk index" for the transition matrix. Since the risk index primarily reflects the mean of forecasted intensity of the hurricane, it contains little information about the uncertainty of the forecast.

Regnier (2008) viewed the hurricane evacuation problem from the perspective of public officials with the authority to order hurricane evacuation. She used a stochastic model of storm motion derived from historic tracks to show the relationship between lead-time and track uncertainty for Atlantic hurricanes, using a discrete Markov model. She showed that being able to tolerate no more than a 10% probability of failing to evacuate before a striking hurricane (a false negative) implies that at least 76% of evacuations will be false alarms. She also showed that reducing decision lead-times from 72 to 48 hours for major population centers could save an average of hundreds of millions of dollars for the region surrounding each target in evacuation costs annually, assuming 460 miles of coastline evacuated.

None of the many contributors to the dynamic action-timing decision problem has considered the optimal investment decision based on the improvement of track and intensity forecasts and of evacuation speed. By modeling these factors, we will derive the optimal investment policy.

The literature dealing with forecast verification and value is extensive. See Katz and Murphy (1997) and Jolliffe and Stephenson (2003) for an overview, for example. In this paper we adopt the distribution-oriented framework proposed by Murphy and Winkler (1987; 1992).

3. MODEL

If evacuation incurred no cost, that would be the best policy under even the slightest possibility of a hurricane. In reality, the decision whether to evacuate may incur the cost of a false positive or a false negative. If the decision can be deferred, then more information can be collected, which could improve the likelihood of making the best decision. However, information gathering can be costly and delayed evacuation could bring about catastrophic loss. Therefore, the DM would be advised to re-evaluate the value of deferring a decision as additional information and a revised estimate on the future event become available.

In our model, we presume to know when the storm may strike the target, denoted as stage N , the final stage in our model. Once stage N is reached, the storm either has struck the target or will never strike it.

3.1 Dynamic programming model

McCardle (1985) suggested a dynamic programming model to handle multi-stage information acquisition and the technology adoption decision problem. Even though the nature of his problem is different from that of our problem and his model is not quite suited to our problem, his basic approach using the dynamic programming to the multi-stage decision matches with our problem. Therefore, we use dynamic programming to model this problem. At every stage, the DM has three alternatives: Ignore, Act, or Wait. If the DM decides to ignore the approaching hazard, he ceases to collect updated information about the hazard or to take any protective action. This incurs no cost until the final stage. If the hurricane does not strike the target at stage N , the cost remains zero. However, if the hurricane does strike the target at the final stage, there is loss.

If at stage j , the DM decides to ignore the upcoming hazard and to stay, the loss of $L_N(t_j)$ occurs with probability s_j . Here, s_j is the DM's current estimate of the strike probability, which is subject to Bayesian updating as additional information is collected. Therefore, the expected loss when the DM chooses to ignore is $s_j L_N(t_j)$.

If at stage j , the DM decides to take action immediately, cost of the protective action is incurred. Also, there can be some loss at stage N if the protective action is not perfect or early enough. The loss level is a function of action timing and the landfall intensity of the hurricane. The loss occurs with probability s_j .

If the DM decides to defer the decision and wait for any new information, the cost of gathering more information, monitoring the situation, or having resources ready for immediate action can be incurred. In many cases, the cost of deferring the immediate

decision could be negligible compared to the other costs. If the DM decides to defer the decision, the optimal decision at the next stage depends on the additional information and the DM's revised estimate based on the information. The optimal decision at the next stage can be "Ignore," "Act," or "Wait," depending on the revised belief.

Let $V_j(s_j, t_j)$ be the anticipated expense from following an optimal policy at stage j , when s_j is the DM's current belief on the strike probability and t_j is the DM's current estimate of the landfall intensity based on the Saffir-Simpson Hurricane Scale. This leads to the following dynamic programming functional equation:

$$V_j(s_j, t_j) = \min \{s_j L_N(t_j), C_j + s_j \cdot L_j(t_j), \gamma + \bar{V}_{j+1}(s_j, t_j)\} \quad (1)$$

$$\text{for } s_j \in \{0, .05, \dots, .95, 1\}, \quad t_j \in \{0, 1, 2, 3, 4, 5\}$$

$$\begin{aligned} \bar{V}_{j+1}(s_j, t_j) &\equiv \sum_{s_{j+1}, t_{j+1}} p_{s_j, s_{j+1}} q_{t_j, t_{j+1}} V_{j+1}(s_{j+1}, t_{j+1}) \\ &= \sum_{s_{j+1}, t_{j+1}} p_{s_j, s_{j+1}} q_{t_j, t_{j+1}} V_{j+1}(s_{j+1}, t_{j+1}) \end{aligned}$$

$$\bar{V}_N(s_{N-1}, t_{N-1}) = s_{N-1} L_N(t_{N-1}).$$

The right hand side of the first equation has three parts. The first part is the expected expense when "Ignore" is selected, given s_j and t_j . The second part is the expected expense when "Act" is selected, given s_j and t_j . The third part is the expected expense when "Wait" is selected. γ is the cost of gathering additional information by waiting one more period. $\bar{V}_{j+1}(s_j, t_j)$ is the expected value from following an optimal policy at stage $j+1$ given the DM's estimate of s_j and t_j at stage j . $\bar{V}_N(s_{N-1}, t_{N-1})$ or terminal value of $\bar{V}_{j+1}(s_j, t_j)$ is the value of decision "Ignore" at stage $N-1$ because if "Wait" is selected at stage $N-1$, the DM has no choice but to face the outcome. $p_{s_j, s_{j+1}}$ is the transition probability of strike probability from s_j at stage j to s_{j+1} at stage $j+1$. $q_{t_j, t_{j+1}}$ is the transition probability of landfall intensity from t_j at stage j to t_{j+1} at stage $j+1$. Transitions of the two state variables, that is, strike probability and landfall intensity, are assumed to be independent of each other. Therefore, the joint probability of the transitions of the two state variables is the product of the two transition probabilities.

If the hurricane strike is highly probable and its intensity is high, the optimal decision will be "Act" in general. However, even though hurricane strike is certain, the optimal decision would be "Ignore" if the cost of prevention exceeds the loss avoidance.

3.2 Expense structure

We assume that the expense from the hurricane includes the cost of protective action including evacuation and the loss from the hurricane striking. These quantities depend on the timing of evacuation. If evacuation starts at stage j , an irrevocable cost C_j is incurred. If the hurricane hits the target, a level of loss is incurred that is usually related to the number of people

who have not evacuated. The loss level is also related to the storm's strength. Therefore, loss level can be defined as a function of evacuation timing and landfall intensity of the hurricane (which would be zero if the hurricane never hits the target).

If, at stage j , people decide to stay throughout the remaining stages, there will be no immediate cost. If the hurricane hits the target, loss level is a function of landfall intensity of the hurricane, since the number of human lives and properties unprotected in the target does not change. If the hurricane does not hit the target, then no expense is associated with the hurricane. The expenses in different cases are summarized in Table 1.

Table 1. Expense table

	Outcome	Hit	Not Hit
Decision			
Evacuate at j		$C_j + L_j(t_j)$	C_j
Do not evacuate		$L_N(t_j)$	0

In Table 1, C_j is the cost of evacuation if people start evacuating at stage j . Therefore, C_j is a function of action timing. $L_j(t_j)$ is the loss level when people start evacuation at stage j and the hurricane of intensity t_j strikes the area at stage N . $L_N(t_j)$ is the loss level when at stage j , people decide to stay through stage N and the hurricane of intensity t_j strikes the area at stage N .

Our model does not place any restriction on the non-negative functions C_j and $L_j(t_j)$, but our first example assumes that the cost of evacuation is constant and the loss from the hurricane is an increasing linear function of timing of evacuation if the intensity is ignored. Fig. 2 shows an example of such an expense function. The cost of evacuation is always 1, no matter when it begins. Loss from hurricane strike is lowest if evacuation starts at stage 0. Starting evacuation any later than stage 0 provides insufficient time to fully protect life or property. Our model assumes that the DM can make a decision only at discrete points of time and the protective action can be started only at the points, not in between. However, even if the action is started between any consecutive stages, the percentage fully protected is proportional to the remaining time before the final stage.

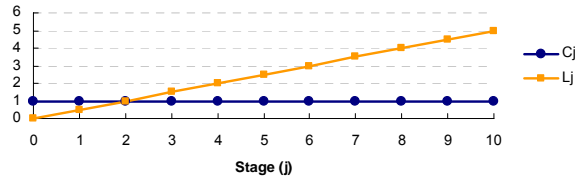

Fig. 2. Expense as a function of evacuation timing

The level of loss is closely related to the timing of action and the landfall intensity. We can define the loss as a function of action timing and landfall intensity as follows:

$$L_j(t_j) = \frac{j}{N} \frac{t_j}{t_{\max}} L_N \quad j \in \{0, 1, \dots, N-1, N\} \quad 0 \leq t_j \leq t_{\max} \quad (2)$$

In this definition, j is the stage index and N is the final stage or the stage of landfall. L_N is the highest level of loss, which is incurred when nobody evacuates until landfall and the most intense hurricane strikes the target, in this example. If the landfall intensity of the hurricane is highest, say category 5, then the loss level is 100% of the amount determined by the action timing. If the landfall intensity is insignificant, then the loss level is 0% of what is determined by the action timing.

In this equation, t_j is the DM's estimate of the landfall intensity of the hurricane when the DM is at stage j . t_{\max} is the maximum intensity the hurricane can have, say category 5. Therefore, maximum intensity is a necessary condition for the loss level to reach L_N . In this example of loss function, the loss level is maximal when t_j has maximum value and current stage is N . However, action timing of N is not necessarily a necessary condition of the maximum loss level in general, because earlier action could result in a worse outcome.

3.3 Markov Chain model

We use a Markov Chain to represent the revision of a DM's estimate of the key parameters. Given prior value of the state variable, how the DM updates that variable upon arrival of information is determined by transition probability matrices, which represent the distribution of the posterior estimate of a state variable given the prior estimate. We use two state variables: S_j and T_j . Each has a corresponding transition matrix. Transition probabilities $p_{s_j, s_{j+1}}$ and $q_{t_j, t_{j+1}}$ are represented

by different transition probability matrices. Each element of the matrix represents conditional probability of state transition given prior state. When a tropical storm is detected, a DM's initial estimate of strike probability and the intensity of the storm if it hits the area may be based on forecasts from The Weather Channel (TWC), National Hurricane Center (NHC), National Weather Service (NWS), or local weather forecaster; opinions of experts in related fields; historic data; or previous knowledge and experience. If a DM decides to defer immediate decision and wait until the next stage, new information can influence the DM's prior belief. This process recurs at each stage.

For example, at stage 1, $p_{.2, .3}$ means the transition probability that the DM's prior estimate of strike probability at stage 1 is revised from .2 to .3 at the next stage. Likewise, $q_{2, 3}$ means the transition probability that the DM's prior estimate of landfall intensity at stage 1 is revised from 2 to 3 at the next stage.

Our model assumes that the DM's belief is consistent such that $E[S_{j+1}|S_j=s_j] = s_j$ and $E[T_{j+1}|T_j=t_j] = t_j$. In other words, if the DM's prior estimate is θ , the mean of possible posterior beliefs is also θ .

The DM's estimates of strike probability and of landfall intensity are revised at each stage, independent of each other. However, the transition matrices will not be identical for all stages if the transition probabilities differ depending on stages or lead-time before landfall. For example, in early stages, the DM's prior estimate of strike probability does not change much. Therefore, the

variance of the transition distribution is small. However, if landfall is imminent, the DM's prior estimate of strike probability moves toward 1 or 0 instead of staying close to the prior value.

3.4 Strike probability and its variance

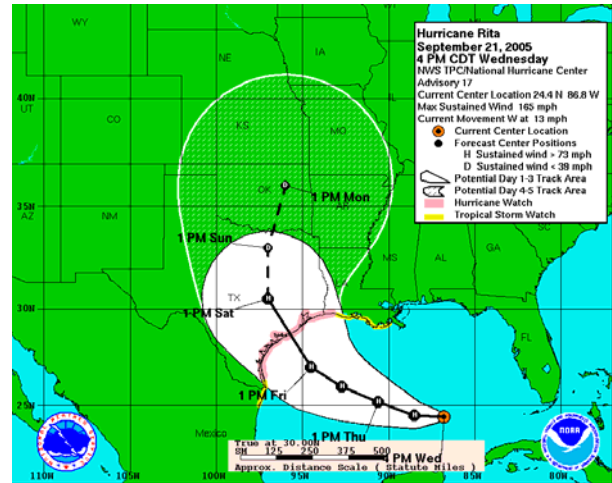

Fig. 3. Cone of uncertainty (image from National Hurricane Center)

Fig. 3 is an image that shows the track forecast of a hurricane. This unique graphic is called “forecast cone,” “track forecast cone,” “cone of uncertainty,” “cone of probability,” “cone of error,” and “cone of death.” (Broad et al. 2007) The cone in the figure covers 67% of possible track of the hurricane center. We will call the cone “uncertainty cone” and the cone circle “uncertainty circle” hereafter. In the early stages, the range of possible prior value of state variable S_j is limited. Generally, when the hurricane center is far from the shore, strike probability for an on-shore target is very low. If the hurricane center is close to the target and the target is still in the uncertainty cone, strike probability is much higher. In other words, strike probability is low when the area of error circle, where the target is in, is large, and it is high when the area is small. Therefore, the strike probability can be roughly defined as a constant times a target area divided by the area of the uncertainty circle. As we can see in Figure 3, the radius of each uncertainty circle is almost proportional to the distance from the current hurricane center or remaining time until strike as shown in Table 2. Since the variance is the square of standard deviation and the area of uncertainty circle is a constant times the square of the radius, we can infer that the variance of strike probability is proportional to the reciprocal of the square of remaining distance or periods.

Table 2. Radii of NHC forecast cone circles for 2007, based on error statistics from 2002-2007 (table adapted from NHC)

Forecast periods (hours)	2/3 Probability Circle, Atlantic Basin (nautical miles)
12	39
24	69
36	99
48	124
72	179
96	252
120	326

Regnier (2008) determined the range of conditional strike probabilities at four different target locations as a function of lead-time. Her graph shows that as lead-time declines, the strike probability of striking storms increases and converges to one and that of non-striking storms decreases to zero. However, a striking storm and a threatening but non-striking storm may have similar initial strike probabilities. Dispersion of strike probability is proportional to the reciprocal of the lead-time. When lead-time is great, such as more than 30 hours, it is usually difficult to determine whether a storm will be striking or non-striking.

On the other hand, the uncertainty cone in Figure 3 can be simplified and compared for different lead-times as in Fig. 4.

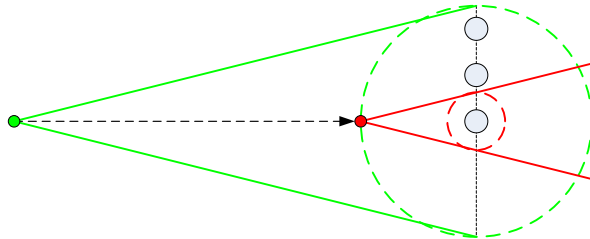

Fig. 4. Cone of uncertainty for different lead-times

In Fig. 4, we assume that the hurricane moves in a straight line. As the hurricane center approaches the target location, the area of the circle in the corresponding uncertainty cone decreases while the area of the target remains constant. The gray circle is the target location, typically a coastal city within the initial uncertainty cone. Green and red dots represent the hurricane center as it moves. The dashed green circle represents the possible locations of the hurricane center in four periods from when the hurricane center is at the green dot. The dashed red circle represents the possible locations of the hurricane center in one period from when the hurricane center is at the red dot.

Assume that the actual landfall locations are normally distributed around the center of the uncertainty circle on the vertical black dashed line and that the radius of the uncertainty circle is the standard deviation. Then the strike probability $p(S)$ is calculated as follows:

$$p(S) = \int_a^b \frac{1}{\sigma\sqrt{2\pi}} e^{-\frac{(x-\mu)^2}{2\sigma^2}} dx = \Phi\left(\frac{b-\mu}{\sigma}\right) - \Phi\left(\frac{a-\mu}{\sigma}\right),$$

where a and b are the relative locations of the boundaries of the target area from the center of the uncertainty circle, $\Phi(\)$ is the standard normal cumulative distribution, μ is the mean, and σ is the standard deviation of the landfall location distribution. For example, if standard deviation is 4 when lead-time is four periods, standard deviation is 1 when lead-time is one period, and radius of the target is .4, the strike probabilities for the target located at the center of the uncertainty circle when lead-time is four periods and one period are calculated as follows:

$$p_4(S) = \int_{-.4}^{.4} \frac{1}{4\sqrt{2\pi}} e^{-\frac{(x-0)^2}{2 \cdot 4^2}} dx = \Phi\left(\frac{.4-0}{4}\right) - \Phi\left(\frac{-.4-0}{4}\right) = 0.079656$$

$$p_1(S) = \int_{-.4}^{.4} \frac{1}{1\sqrt{2\pi}} e^{-\frac{(x-0)^2}{2 \cdot 1^2}} dx = \Phi\left(\frac{.4-0}{1}\right) - \Phi\left(\frac{-.4-0}{1}\right) = 0.310843.$$

If we select all the possible targets in the initial uncertainty circle, in which lead-time is 4 periods, and plot the strike probabilities for each target, the shape looks as in Fig. 5. When lead-time is 4 periods, the target in the middle and the one at the boundaries have similar strike probabilities between 0.05 and 0.08. However, when the lead-time is 1 period, strike probability differs a lot depending on the target location. Strike probabilities for the targets that are still in the shrunk uncertainty circle increase noticeably. But, strike probabilities for the targets which are far from the shrunk uncertainty circle approach 0.

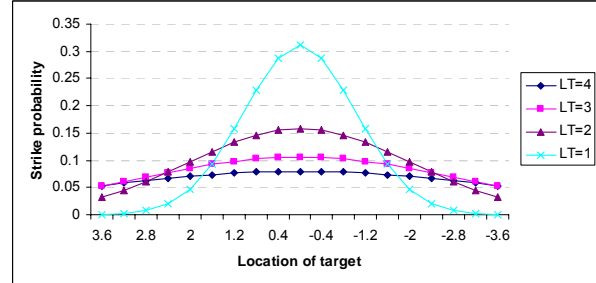

Fig. 5. Distribution of strike probabilities for different lead-times

The range of strike probabilities for all the targets is plotted in Fig. 6. When lead-time is 4 periods, strike probabilities for all the targets are distributed in a small range between 0.05 and 0.08. As the lead-time increases, the probabilities become more and more dispersed. When the lead-time decreases to 1 period, the strike probabilities for the same targets become much more dispersed. Strike probability for boundary targets approaches 0 and strike probability for the targets in the middle increases sharply. In other words, when lead-time becomes shorter, strike probabilities become more widely dispersed.

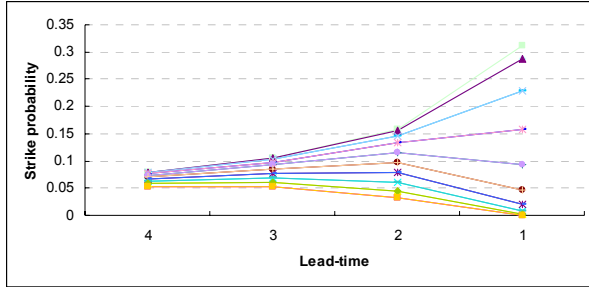

Fig. 6. Range of strike probabilities as a function of lead-time

When the lead-time becomes longer, the area of the uncertainty circle becomes larger and the area of the target location becomes smaller, implying low chance of strike.¹ When the lead-time becomes shorter, the area of the uncertainty circle becomes smaller and the area of the target becomes larger compared to the uncertainty circle, but it does not necessarily lead to high chance of strike. If the target location is within the final uncertainty cone like the lowest dot in Figure 4, strike probability grows sharply when landfall is imminent. However, if the target shifts outside the uncertainty cone due to the hurricane direction change, strike possibility drops toward 0.

As implied from Fig. 5 and 6, the variance of strike probabilities for the targets increases sharply as the lead-time approaches 0. Fig. 7 shows the variance as a function of lead-time. It shows that three fourths shorter lead-time makes the variance over 150 times bigger.

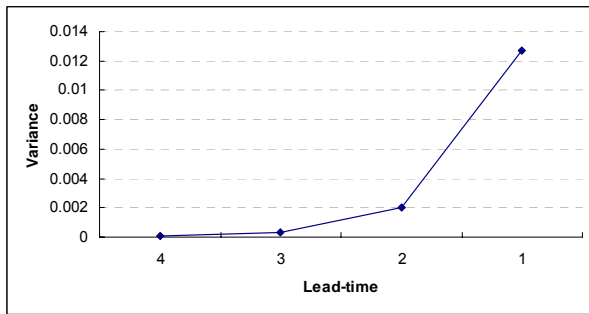

Fig. 7. Variance of strike probabilities for the targets

This result matches the work of Regnier (2008) very well. This observation implies that the variance of strike probability increases as lead-time decreases even though it varies depending on the location of the target relative to the hurricane track. The observation also implies that as the strike probability for a target in the cone increases, variance of strike probabilities for any target also increases. Since the area of the uncertainty circle is proportional to the square of radius and the variance of strike probability is the square of standard deviation, we can infer that the variance of strike

¹ According to National Hurricane Center (NHC), strike probability is the chance of the center of the hurricane passing within 65 nautical miles or 75 statute miles of the target location.

probability is proportional to the reciprocal of the square of the uncertainty circle radius. If we assume that the angle of the uncertainty cone doesn't change as the hurricane moves, we can infer that the radius of the uncertainty cone is proportional to the lead-time before landfall. Then, we can define the variance of strike probabilities at stage j as follows:

$$\sigma_j^2 = \frac{K_s}{(N-j)^2} \quad j \in \{0, 1, \dots, N-2, N-1\} \quad (3)$$

In this definition, σ_j^2 is the variance of strike probability at stage j and K_s is a constant.

3.5 Landfall intensity and its variance

For a landfall intensity forecast, we use the same definition of α and β as in strike probability. DM's estimation of landfall intensity changes over time but its variance does not change noticeably as we can see in Fig. 8. The figure is the transition probability matrices for landfall intensity, which have been created from 30 hurricanes and tropical storms before year 2006. If lead-time is 4 periods and DM's belief on landfall intensity is Category 1, it changes to other categories with probability 0.2 at the next period. If the DM's belief on landfall intensity is category 3, it changes to other categories with probability 0.4 at the next period. Any significant pattern of dispersion change over time is not observed in the figure.

LT = 4	0	1	2	3	4	5
0	0.857143	0.142857	0	0	0	0
1	0.2	0.8	0	0	0	0
2	0	0	1	0	0	0
3	0	0	0.2	0.6	0.2	0
4	0	0	0	0	0.8	0.2
5	0	0	0	0	0	0

LT = 3	0	1	2	3	4	5
0	0.714286	0.285714	0	0	0	0
1	0.2	0.6	0.2	0	0	0
2	0	0	1	0	0	0
3	0	0	0	0.666667	0.333333	0
4	0	0	0	0.4	0.6	0
5	0	0	0	0	0	1

LT = 2	0	1	2	3	4	5
0	0.857143	0.142857	0	0	0	0
1	0.6	0.4	0	0	0	0
2	0	0.25	0.75	0	0	0
3	0	0	0.25	0.75	0	0
4	0	0	0	0	1	0
5	0	0	0	0	0	1

LT = 1	0	1	2	3	4	5
0	1	0	0	0	0	0
1	0.25	0.75	0	0	0	0
2	0	0.25	0.5	0.25	0	0
3	0	0	0	0.666667	0.333333	0
4	0	0	0.2	0.6	0.2	0
5	0	0	0	0	0	0

Fig. 8. Transition probability matrix of landfall intensity from 30 storms

Based on the observation, our model assumes a constant variance of the revision of landfall intensity forecast. Therefore, we use a constant variance K_T for all stages as follows.

$$\sigma_j^2 = K_T \quad j \in \{0, 1, \dots, N-2, N-1\}$$

Because the forecast of landfall intensity does not change dramatically when lead-time approaches 0, transition matrices have a nearly diagonal shape for all stages.

3.6 How to manipulate transition matrices

In order to make the transition probability matrices best represent the nature of the revision of DM's belief, we need to manipulate the transition probability matrices. Furthermore, we need to represent the improved forecasting within transition probability matrices by controlling them. To control the matrices, we need to use a well-defined flexible probabilistic distribution that can be manipulated by a few parameters.

Our model uses Beta distribution to do the job. The pdf function is defined as follows:

$$f(x) = \frac{1}{B(\alpha, \beta)} x^{\alpha-1} (1-x)^{\beta-1} \quad x \in [0, 1]$$

$$, \text{ where } B(\alpha, \beta) = \int_0^1 t^{\alpha-1} (1-t)^{\beta-1} dt.$$

Beta density function can take on different shapes depending on the values of two parameters α and β . Its shape can be U-shaped, strictly decreasing or increasing, strictly convex or concave, straight line, uniform, or unimodal. In early stages of hurricane forecast, strike probability does not change a lot over time as we can see in Fig. 6 and the transition matrix is almost diagonal. At close-to-final stages, as we can see in Fig. 6, strike probabilities change noticeably toward 0 or 1, rather than in between, and therefore the transition matrix has U shape in each row. Table 3 shows an example of such matrices. Initial transition probability matrix for strike probability looks like the left one in the table and it ends up with the right one at the end. In the left matrix, transition distribution in each row has symmetric bell-shape except very certain cases, i.e. prior belief of 0 and 1. In other words, it is highly probable that the DM's belief on strike probability does not change after the transition of period. In the right matrix, transition distribution in each row has U-shape, except the very certain cases, because the transition is distributed at two extremes, not in between. This dramatic change of distribution can be made in Beta distribution.

Table 3. Example of the first and the last transition probability matrices

1	0	.2	.4	.6	.8	1
0	.95	.05				
.2	.05	.90	.05			
.4		.05	.9	.05		
.6			.05	.9	.05	
.8				.05	.9	.05
1					.05	.95

→

N	0	.2	.4	.6	.8	1
0	1					0
.2	.8					.2
.4	.6					.4
.6	.4					.6
.8	.2					.8
1	0					1

Another good feature of Beta distribution is that it is supported on a bounded interval [0, 1] and the model does not have to truncate unnecessary tails of transition distribution outside the valid range.

How we generate transition probability matrix for each stage is explained here. We suppose the conditional transition distribution is Beta(α , β), the prior value of state variable is the mean μ of this distribution, and the variance defined in section 3.4 and 3.5 is the variance σ^2 of this distribution. Since the mean of the conditional transition distribution should be same as the prior value of state variable and the mean of Beta(α , β) is $\alpha/(\alpha+\beta)$, the equation $\alpha/(\alpha+\beta) = \mu$ should hold. Since the variance of Beta(α , β) is $\alpha\beta/((\alpha+\beta)^2(\alpha+\beta+1))$, put it as $\sigma^2 = \alpha\beta/((\alpha+\beta)^2(\alpha+\beta+1))$. Now, we can redefine α and β in terms of μ and σ^2 as follows:

$$\alpha = \frac{(1-\mu)\mu^2}{\sigma^2} - \mu$$

$$\beta = \frac{\mu(1-\mu)^2}{\sigma^2} + \mu - 1.$$

Now, we can define the conditional transition distribution in terms of mean and variance. Since the parameters α and β should have positive value, there are restrictions on the range of acceptable values of μ and σ^2 .

New information at near final stages gives big impact to the state variable s_j , thus more dispersed transition distribution. So, we use changing variance which grows faster as it approaches the final stage. To calculate the variance at each stage, a number reciprocally proportional to the square of remaining periods before landfall is used with a scale parameter. In our model, variance at stage j is defined as $K_S/(N-j)^2$ as in Equation (3), where K_S is a scale parameter and N is the final stage when landfall is made. In early stage, say $j = 1$, the variance grows slowly. But it grows sharply as it approaches the final stage, say $j = N-1$. With the given mean and the calculated variance, transition distribution of each row of transition matrix at each stage is defined as a beta distribution and each transition probability is determined by the discretization of the distribution.

If the prior value of state variable S_j is very close to 0, because the target is far outside the uncertainty cone, or very close to 1, because the target is right on the estimated track of the imminent hurricane, the calculated value of α or β can be non-positive, which is not acceptable for beta distribution. To prevent this problem, our model has absorbing states for state

variable S_j . If the value of state variable S_j changes to 0 or 1 after discretization, it cannot leave the state for the remaining stages. In other word, once the state variable has the value 0 or 1 the probability that it stays at the same state in the next stage is 1. Due to the absorbing states, transition probabilities associated with prior state 0 and 1 has special values as follows:

$$p_{0,0} = p_{1,1} = 1$$

$$p_{0,1} = p_{0,2} = \dots = p_{0,9} = p_{0,1} = p_{1,0} = p_{1,1} = \dots = p_{1,8} = p_{1,9} = 0$$

Other transition probabilities are defined as follows:

$$p_{s_i, s_j} = \int_{s_j - ds/2}^{s_j + ds/2} f(x) dx$$

In this equation, s_i is prior value of the state variable before the transition and s_j is its posterior value after the transition. ds is the interval between the consecutive values of the state variable. $f(x)$ is pdf function of beta distribution defined by s_i as mean and the calculated variance. For example, if ds is .1, $p_{1,2}$ is defined as follows:

$$p_{1,2} = \int_{1.15}^{2.15} f(x) dx \cdot$$

The mean of beta distribution is .1 in this example and the pdf function $f(x)$ is defined accordingly.

Likewise, if the prior value of state variable T_j is very close to 0, because the storm is thought to be dissipating, or very close to 5.5, because the maximum strength storm is very close to the target and does not seem to lose its power, the calculated value of α or β can be non-positive, which is not acceptable for Beta distribution. To prevent this problem, our model has absorbing states for state variable T_j . If the value of state variable T_j changes to 0 or 5.5 it cannot leave the state. In other word, once the state variable has the value 0 or 5.5 the probability that it stays at the same state in the next stage is 1. Due to the absorbing states, transition probabilities associated with prior state 0 and 5.5 has special values as follows:

$$q_{0,0} = q_{5.5,5.5} = 1$$

$$q_{0,5} = q_{0,1} = \dots = q_{0,5} = q_{0,5.5} = q_{5.5,0} = q_{5.5,5} = \dots = q_{5.5,1} = q_{5.5,5} = 0$$

Other transition probabilities are defined as follows:

$$q_{t_i, t_j} = \int_{t_j - dt/2}^{t_j + dt/2} g(y) dy \cdot$$

In this equation, t_i is prior value of the state variable before the transition and t_j is its posterior value after the transition. dt is the interval between the consecutive values of the state variable. $g(y)$ is pdf function of beta distribution defined by t_i and the calculated variance. For example, if dt is .5, $q_{1,2}$ is defined as follows:

$$q_{1,2} = \int_{1.75}^{2.25} g(y) dy \cdot$$

The mean of beta distribution is 1 in this example and the pdf function $g(y)$ is defined accordingly.

In the transition probability matrix of state variable S_j for close-to-final stages, transition distribution of each row approaches complete U-shape, which means perfect information, the calculated value of α or β can be

non-positive, which is not acceptable for beta distribution. If this is the case, transition probabilities are calculated to keep the DM's rationality as follows:

$$\begin{aligned} p_{s_i, s_j} &= 1 - s_i \text{ if } s_j = 0 \\ &= s_i \text{ if } s_j = 1 \\ &= 0 \text{ otherwise.} \end{aligned}$$

By this definition, $E[S_j|S_i=s_i] = (1-s_i)0 + s_i \cdot 1 = s_i$ and the mean of transition does not change. Using our Markov Chain model, the pattern of the range of strike probability at each stage matches the work of Regnier (2008) very well as illustrated in Fig. 9. In this example, transition probabilities less than 0.1 are ignored to remove thin tails from each transition distribution. To discretize the value of strike probabilities, this example used 11 categories from 0 to 1. In this figure, DM's belief on the strike probability starts from 0.1 and it does not change in early stages because the new information available at this time is not strong enough to impact the DM's belief. As lead-time decreases, the new information becomes stronger and begins to influence the DM's belief. As the final stage approaches, the new information gains more and more power and the DM becomes more certain about whether the hurricane will strike the target or not. At the final stage, the DM knows the outcome for sure.

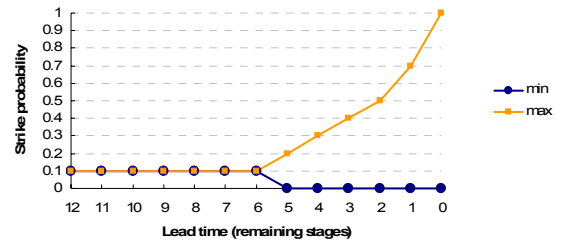

Fig. 9. Range of strike probability at each transition

3.7 Illustrative example

Table 4 shows different combinations of strike probability and landfall intensity. Each combination shows its optimal policy at stage 0 using our model. In this table, "I" means that "Ignore" is the optimal decision, "A" means that "Act" is the optimal decision, and "W" means that "Wait" is the optimal decision.

The table shows that "Ignore" is optimal when strike probability is very low or landfall intensity is very low, while "Act" is optimal when strike probability and landfall intensity are not very low.

State variable S_j has 21 categories from 0 to 1; state variable T_j has 12 categories from 0 to 5.5. If the value of T_j is 0, it means the classification of the storm is tropical depression or negligible. 0.5 means the classification is tropical storm, which is less intense than category one hurricane. 1 means lower half range of category 1 hurricane and 1.5 means higher half range of category 1. Likewise, 2, 3, 4, and 5 means lower half range of category 2, 3, 4, 5, and 2.5, 3.5, 4.5, and 5.5 means higher half range of each category. Each

category of Saffir-Simpson Hurricane Scale is separated into lower and higher category of each to avoid too coarse discretization in the transition probability matrices.

Table 4. An example of optimal policies

$s_0 \backslash t_j$	0	0.5	1	1.5	2	2.5	3	3.5	4	4.5	5	5.5
0	I	I	I	I	I	I	I	I	I	I	I	I
0.05	I	I	I	I	I	I	I	I	W	W	W	I
0.1	I	I	I	W	W	W	W	A	A	A	A	A
0.15	I	W	W	W	W	A	A	A	A	A	A	A
0.2	I	W	W	W	A	A	A	A	A	A	A	A
0.25	I	W	W	A	A	A	A	A	A	A	A	A
0.3	I	W	W	A	A	A	A	A	A	A	A	A
0.35	I	W	W	A	A	A	A	A	A	A	A	A
0.4	I	W	W	A	A	A	A	A	A	A	A	A
0.45	I	W	A	A	A	A	A	A	A	A	A	A
0.5	I	W	A	A	A	A	A	A	A	A	A	A
0.55	I	W	A	A	A	A	A	A	A	A	A	A
0.6	I	W	A	A	A	A	A	A	A	A	A	A
0.65	I	W	A	A	A	A	A	A	A	A	A	A
0.7	I	W	A	A	A	A	A	A	A	A	A	A
0.75	I	W	A	A	A	A	A	A	A	A	A	A
0.8	I	W	A	A	A	A	A	A	A	A	A	A
0.85	I	W	A	A	A	A	A	A	A	A	A	A
0.9	I	W	A	A	A	A	A	A	A	A	A	A
0.95	I	W	A	A	A	A	A	A	A	A	A	A
1	I	W	A	A	A	A	A	A	A	A	A	A

Table 5 is an example of optimal policies when the value of t_j is fixed to 1.5. In this example, protective action is not worth the cost when the storm is imminent because the storm is not that strong.

Table 5. An example of optimal policies given $t_j=1.5$ for all j

$s_j \backslash j$	0	1	2	3	4	5	6	7	8	9
0	I	I	I	I	I	I	I	I	I	I
0.05	W	W	W	W	W	W	W	W	W	I
0.1	W	W	W	W	W	W	W	W	W	I
0.15	W	W	W	W	W	W	W	W	I	I
0.2	W	W	W	W	W	W	W	I	I	I
0.25	W	W	W	W	W	W	W	I	I	I
0.3	W	W	W	W	W	W	W	I	I	I
0.35	W	W	W	W	W	W	W	W	I	I
0.4	W	W	W	W	W	W	W	W	I	I
0.45	W	W	W	W	W	W	W	W	I	I
0.5	W	W	W	W	W	W	W	W	I	I
0.55	A	A	A	A	A	W	W	W	I	I
0.6	A	A	A	A	A	A	W	W	I	I
0.65	A	A	A	A	A	A	A	W	I	I
0.7	A	A	A	A	A	A	A	W	I	I
0.75	A	A	A	A	A	A	A	A	W	I
0.8	A	A	A	A	A	A	A	A	W	I
0.85	A	A	A	A	A	A	A	A	W	I
0.9	A	A	A	A	A	A	A	A	W	I
0.95	A	A	A	A	A	A	A	A	A	I
1	A	A	A	A	A	A	A	A	A	I

Table 6 is an example of optimal policies when the value of s_j is fixed to 0.15. In this example, protective action does not have a significant merit when near the final stage because strike probability is not that high.

Table 6. An example of optimal policies given $s_j=.15$ for all j

$t_j \backslash j$	0	1	2	3	4	5	6	7	8	9
0	I	I	I	I	I	I	I	I	I	I
0.5	W	W	I	I	I	I	I	I	I	I
1	W	W	W	W	W	I	I	I	I	I
1.5	W	W	W	W	W	W	W	W	I	I
2	W	W	W	W	W	W	W	W	W	I
2.5	W	W	W	W	W	W	W	W	W	I
3	A	A	W	W	W	W	W	W	W	I
3.5	A	A	A	A	W	W	W	W	W	I
4	A	A	A	A	A	W	W	W	W	I
4.5	A	A	A	A	A	A	W	W	W	I
5	A	A	A	A	A	A	W	W	W	I
5.5	A	A	A	A	A	A	A	W	I	I

4. FORECAST QUALITY AND EVACUATION SPEED

4.1 How to control forecast quality

We need to see what happens if forecast quality improves in our model. To do so, we should control our model to reflect the improvement. Then, how do we control the forecast quality of strike probability? Since forecast quality relates to transition probability matrices, our model controls it through the matrices.

Think about the forecast of strike probability. In Figure 5, we can observe that the DM is more certain about the strike when the uncertainty circle is smaller, which occurs when the lead-time is shorter. Therefore, we can infer that, with better forecast of strike probability, we have narrower uncertainty cone, thus smaller uncertainty circle just like Fig. 6. In other words, narrower uncertainty cone distinguish more clearly targets in danger from safe targets. Smaller uncertainty circle implies more certainty about the hurricane strike and sharper forecast, i.e. 1 or 0 instead of in between. This leads to greater variance of the DM's belief on the strike probability as implied in Equation (3). If the green uncertainty cone improves to the blue one, the radius of the uncertainty circle shrinks at a rate as illustrated in Fig. 6. Using a parameter r_s , the definition of the variance in Equation (3) changes as follows:

$$\sigma_j^2 = \frac{K_s}{(r_s(N-j))^2} = \frac{K_s}{r_s^2(N-j)^2} = \frac{K_s/r_s^2}{(N-j)^2} \quad j < N, 0 < r_s \leq 1$$

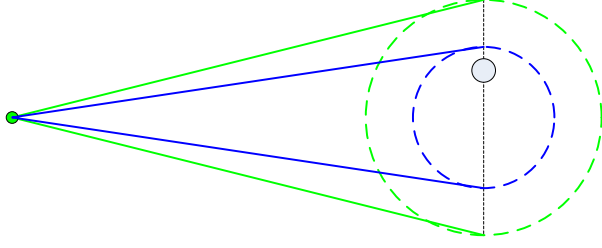

Fig. 10. Cone of uncertainty with different forecast quality

In this definition, K_S is the constant associated with the state variable S_j and r_S is the forecast quality improvement parameter associated with S_j . If strike probability forecast is not improved, r_S equals 1. If the radius of uncertainty circle shrinks to 70% through forecast improvement, r_S is equal to 0.7 and the variance becomes $K_S/0.7^2 = 2.04K_S$, which is about twice the original variance of DM's belief on strike probability. It means that the DM's belief on strike probability becomes sharper and is distributed farther from the climatological average.

Now, what about the forecast of landfall intensity? Unlike the forecast of strike probability, the forecast of landfall intensity does not change noticeably when lead-time decreases to 0 as we talked in section 3.5. Transition matrix for landfall intensity has nearly diagonal shape and the transition distribution in each row has narrow bell-shape. If the forecast improves, the transition matrices will have looser diagonal shape and the transition distribution in each row has wider bell-shape because bad forecast holds the DM's belief close to the prior one while good forecast stimulates the DM's belief to approach the true landfall intensity faster no matter what it is. In other words, good forecast gives much information to revise the DM's belief while bad forecast does not. Therefore, we can control the forecast quality using variance. Using a parameter r_T , the variance of landfall intensity forecast can be defined as follows:

$$\sigma_j^2 = K_T / r_T \quad j < N \quad 0 < r_T \leq 1.$$

In this definition, K_T is the constant associated with state variable T_j and r_T is the forecast quality improvement parameter associated with T_j . If the landfall intensity forecast is not improved, r_T equals 1. If the intensity forecast is improved by 30%, r_T equals .7.

4.2 How to control evacuation speed

Evacuation speed relates to the expense function, which is the sum of evacuation cost and the loss from the hurricane, while forecast quality relates to transition probability matrices. If the effectiveness of evacuation or any protective action improves, lives and properties can be protected in shorter time. Let's call the effectiveness "evacuation speed". If evacuation speed improves, expense structure in Fig. 2 changes to the modified structure like Fig. 11.

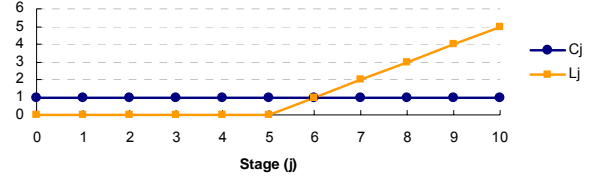

Fig. 11. Example of expense function for improved evacuation speed

In the expense structure in Figure 7, they can finish same level of evacuation within half the original time and they have more time until the critical time for evacuation decision thanks to the faster evacuation. Therefore, faster evacuation lowers the risk of false alarm or miss by allowing more time to collect more information before the evacuation decision. Using a parameter r_E , we can redefine L_j as follows:

$$L_j = \max \left\{ 0, L_{\max} - \frac{N-j}{r_E \cdot N} L_{\max} \right\} \quad 0 < r_E \leq 1.$$

In this definition, r_E is the improvement parameter associated with evacuation speed or effectiveness of protective action. If evacuation speed does not improve, r_E equals 1. If evacuation speed improves by 30%, r_E equals .7, which means same level of evacuation can be finished within 70% of the original time needed. If r_E goes to zero, the evacuation becomes instantaneous evacuation.

If we include the intensity in the definition of loss level, it becomes a function of action timing and storm intensity as follows:

$$L_j(t_j) = \max \left\{ 0, L_{\max} - \frac{N-j}{r_E \cdot N} \frac{t_j}{t_{\max}} L_{\max} \right\} \quad 0 < r_E \leq 1.$$

In this definition, we assume that the loss level is linearly related to the landfall intensity.

4.3 Refined model with improvement parameters

The refined model with the improvement parameters, explained in the previous sections, is summarized as follows:

$$V_j(s_j, t_j) = \min \{ s_j L_N(t_j), C_j + s_j \cdot L_j(t_j), \gamma + \bar{V}_{j+1}(s_j, t_j) \},$$

$$\text{for } s_j \in \{0, .05, \dots, .95, 1\}, \quad t_j \in \{0, 1, 2, 3, 4, 5\}$$

$$\begin{aligned} \bar{V}_{j+1}(s_j, t_j) &\equiv \sum_{s_{j+1}, t_{j+1}} p_{s_j, s_{j+1}} q_{t_j, t_{j+1}} V_{j+1}(s_{j+1}, t_{j+1}) \\ &= \sum_{s_{j+1}, t_{j+1}} p_{s_j, s_{j+1}} q_{t_j, t_{j+1}} V_{j+1}(s_{j+1}, t_{j+1}) \end{aligned}$$

$$\bar{V}_N(s_{N-1}, t_{N-1}) = s_{N-1} L_N(t_{N-1}).$$

Transition probability from s_i to s_j for track forecast is represented by Beta(α, β) defined as:

$$\mu = s_j$$

$$\sigma_j^2 = \frac{K_S / r_S^2}{(N-j)^2} \quad j < N, 0 < r_S \leq 1$$

$$\alpha = \frac{(1-\mu)\mu^2}{\sigma^2} - \mu \quad \text{and} \quad \beta = \frac{\mu(1-\mu)^2}{\sigma^2} + \mu - 1.$$

Transition probability from t_i to t_j for track forecast is represented by Beta(α, β) defined as:

$$\mu = t_j$$

$$\sigma_j^2 = K_T / r_T \quad j < N, 0 < r_T \leq 1$$

$$\alpha = \frac{(1-\mu)\mu^2}{\sigma^2} - \mu \quad \text{and} \quad \beta = \frac{\mu(1-\mu)^2}{\sigma^2} + \mu - 1.$$

$$L_j(t_j) = \max \left\{ 0, \left(1 - \frac{N-j}{r_E \cdot N} \right) \frac{t_j}{t_{\max}} L_{\max} \right\} \quad 0 < r_E \leq 1.$$

In the definitions above, r_S is the improvement parameter for track forecast, r_T is the improvement parameter for intensity forecast, r_E is the improvement parameter for evacuation speed. In the definition of variances, K_S is the constant for the track forecast and K_T is the constant for the intensity forecast. In the definition of L_j , t_j is forecast of landfall intensity estimated at stage j , and t_{\max} is the maximum level of intensity.

4.4 Sensitivity analysis

Using the refined model in the previous section, we can compare improvement of each key factor: track forecast quality, landfall intensity forecast quality, and evacuation speed. An example of the impact of improvement parameters change for forecast quality and evacuation speed is summarized in Table 7. In the table, $V_0(s_j = .15, t_j = 1.5)$ is the anticipated expense from following an optimal policy at stage 0 in a situation that the DM's current belief on the strike probability is 0.15 and the DM's current belief on the landfall intensity is 1.5. Since all the expenses are relative values, the values of $V_0(s_j = .15, t_j = 1.5)$ are also relative ones. The results show that estimated total expense from optimal decision policy is less sensitive to the change of the improvement parameters of forecast quality than that of evacuation speed. It is even less sensitive to the improvement parameter of intensity forecast than that of track forecast. If all the improvements are free and one unit percentage of improvement parameter is allowed, the improvement of evacuation speed is most effective. However, 10% change of improvement parameter does not necessarily mean 10% improvement. Therefore, we cannot conclude which improvement is more valuable than others. Also, since we don't know the price of each improvement, we don't have enough information to conclude which investment should be selected.

Table 7. Impact of improvement parameter for forecast quality and evacuation speed

Improvement of track forecast (1- r_S)	0%	10%	20%	30%	40%	50%
$V_0(s_j=.15, t_j=1.5)$.783595	.776202	.767512	.757352	.744546	.725601
Improvement of V_0	0%	.94%	2.05%	3.35%	4.98%	7.40%
Improvement of intensity forecast (1- r_T)	0%	10%	20%	30%	40%	50%
$V_0(s_j=.15, t_j=1.5)$.783595	.779618	.774578	.768001	.759469	.748146
Improvement of V_0	0%	.51%	1.15%	1.99%	3.08%	4.52%
Improvement of evacuation speed (1- r_E)	0%	10%	20%	30%	40%	50%
$V_0(s_j=.15, t_j=1.5)$.783595	.755466	.722158	.690528	.658597	.626029
Improvement of V_0	0%	3.59%	7.84%	11.88%	15.95%	20.11%

5. PERFECT INFORMATION AND INSTANTANEOUS EVACUATION

If we assume delta property, the value of information at stage j in our model can be defined as follows:

$$\begin{aligned} \text{Vol}_j(s_j, t_j) &= \text{value w/ info} - \text{value w/o info} \\ &= V_j(s_j, t_j) - \min \{ s_j L_N(t_j), C_j + s_j \cdot L_j(t_j) \} \end{aligned}$$

The value of V_j with perfect information shows the upper bound value it can have by improving information quality and the value of perfect information shows the most amount the DM is willing to pay for the information. Assuming delta property, the value of perfect information (VoPI) can be defined as follows:

$$\text{VoPI} = \text{value w/ perfect info} - \text{value w/o info}.$$

If we have perfect information, alternative "Wait" can no longer be optimal because we already have everything we can get by waiting. Figure 12 shows the decision tree when we have perfect information about storm track. The perfect information tells if the storm will hit the target or not for sure.

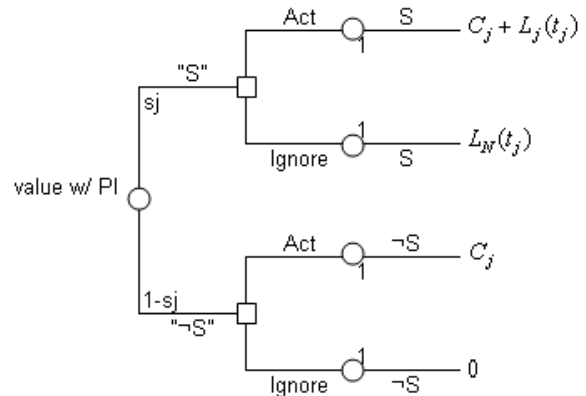

Fig. 12. Decision tree with perfect information about storm track

Likewise, the value of V_j with instantaneous evacuation shows the upper bound value it can have by improving evacuation speed. Assuming delta property, the value of instantaneous evacuation (VoIE) can be defined as follows:

VoIE = value w/ instantaneous evacuation - value w/o instantaneous evacuation.

We use “w/o instantaneous evacuation” instead of “w/o evacuation” since the problem cannot be defined without the option to evacuate. To compare the value of perfect information with VoIE, we define the additional value of perfect information as compared to the value with current level of information (ΔVoPI) as follows:

ΔVoPI = value w/ perfect info - value w/ info.

Therefore, assuming delta property, the additional value of perfect information about storm track at stage j in our model can be defined as follows:

$$\begin{aligned}\Delta\text{VoPI}_j(s_j, t_j) &= s_j \min\{L_N(t_j), C_j + L_j(t_j)\} + (1-s_j) \min\{0, C_j\} - V_j(s_j, t_j) \\ &= s_j \min\{L_N(t_j), C_j + L_j(t_j)\} + (1-s_j)0 - V_j(s_j, t_j) \\ &= s_j \min\{L_N(t_j), C_j + L_j(t_j)\} - V_j(s_j, t_j)\end{aligned}$$

If we assume that the $L_N(t_j) > C_j + L_j(t_j)$, ΔVoPI can be simplified as:

$$\Delta\text{VoPI}_j(s_j, t_j) = s_j (C_j + L_j(t_j)) - V_j(s_j, t_j) \quad (4)$$

If we have instantaneous evacuation available, we don't have to collect any more information until we can observe the outcome: hit or not. In other words, if this is the case, we can obtain and use the perfect information at the final stage without additional cost for information gathering. With instantaneous evacuation, if we observe the landfall at the final stage, it is optimal to start the instantaneous evacuation. If we observe no landfall at the final stage, it is optimal to take no action. Therefore, if we believe at stage j that the hurricane will hit the target at probability s_j , assuming delta property and $L_N(t_j) > C_N$, the value of instantaneous evacuation estimated at stage j in our model can be defined as follows:

$$\begin{aligned}\text{VoIE}_j(s_j, t_j) &= s_j \min\{L_N(t_j), C_N\} + (1-s_j) \min\{0, C_N\} - V_j(s_j, t_j) \quad (5) \\ &= s_j C_N + (1-s_j)0 - V_j(s_j, t_j) \\ &= s_j C_N - V_j(s_j, t_j)\end{aligned}$$

If we compare Equation (4) and (5), we can see that ΔVoPI equals VoIE on condition that:

$$L_N(t_j) > C_j + L_j(t_j)$$

$$L_N(t_j) > C_N$$

$$L_j(t_j) = 0.$$

Our model has perfect information about track forecast when the value of r_S is very close to 0. Our model has instantaneous evacuation when the value of r_E is very close to 0. Actually, it has instantaneous evacuation when the value of r_E is less than or equal to $1/N$ because r_E needs to be small enough to make the loss function $L_j(t_j)$ equal to 0 for all $j < N$. Our model can improve the intensity forecast by changing the value of

r_T but cannot have perfect information about landfall intensity just by changing the value of r_T .

The values of V_0 with perfect information about strike probability forecast, landfall intensity forecast, and instantaneous evacuation are shown in the following. In the same setting, $V_0(s_0=.15, t_0=1.5)$ with perfect information about strike probability is 0.232066, which is 70.38% improvement. $V_0(s_0=.15, t_0=1.5)$ with instantaneous evacuation is 0.412143, which is 47.40% improvement. $V_0(s_0=.15, t_0=1.5)$ with perfect information about strike probability and instantaneous evacuation is 0.114854, which is 85.34% improvement. These percentages are the upper bounds of improvement of the value of V_0 when improving track forecast, evacuation speed, or both.

6. CONCLUSION AND FUTURE RESEARCH

We designed the framework to show the value of improved forecast and improved evacuation speed in the dynamic multi-stage decision setting with example results. Using this framework, we can see how much value the improved evacuation can give, compared to the improved forecast. Improved forecast lowers the chance of false alarm or miss while faster evacuation gives more time to wait for more information without increasing the risk of loss from the hurricane. In our model, forecast quality and evacuation speed are controlled by improvement parameters r_S , r_T , and r_E . The sensitivity analysis of the anticipated expense to these parameters shows that the improvement of evacuation speed has greater influence on the anticipated expense than forecast quality in the example. If cost of improvement or technical difficulty does not matter, investment in improving evacuation speed looks more attractive. However, we cannot derive a general result from the example.

Before we make the final investment decision, we need to know how much change of a parameter value is equivalent to unit improvement of forecast quality and evacuation speed depending on their measures. The cost of each improvement will also be a key factor for the decision. Future research will consider how much change of the parameter value is equivalent to unit improvement of forecast quality and evacuation speed for different measures. In addition, more realistic cost function and prices for the improvements will be considered. By doing so, we will be able to answer the question more clearly: roads or radar.

7. REFERENCES

- Ahn, J.-H., and J. J. Kim, 1998: Action-timing problem with sequential Bayesian belief revision process. *European Journal of Operational Research*, **105**, 118-129.
- Broad, K., A. Leiserowitz, J. Weinkle, and M. Steketee, 2007: Misinterpretation of the "Cone of Uncertainty" in Florida during the 2004 Hurricane Season. *Bulletin of the American Meteorological Society*, **88**, 651-667.
- Considine, T. J., C. Jablonowski, B. Posner, and C. H. Bishop, 2004: The Value of Hurricane Forecasts to Oil and Gas Producers in the Gulf of Mexico. *Journal of Applied Meteorology*, **43**, 1270-1281.
- Howard, R. A., 1966: Dynamic Programming. *Management Science*, **12**, 317-348.
- McCardle, K. F., 1985: Information Acquisition and the Adoption of New Technology. *Management Science*, **31**, 1372-1389.
- Mjelde, J. W., D. S. Peel, S. T. Sonka, and P. J. Lamb, 1993: Characteristics of Climate Forecast Quality: Implication for Economic Value to Midwestern Corn Producers. *Journal of Climate*, **6**, 2175-2187.
- Murphy, A. H., and M. Ehrendorfer, 1987: On the Relationship between the Accuracy and Value of Forecasts in the Cost-Loss Ratio Situation. *Weather and Forecasting*, **2**, 243-251.
- Regnier, E., 2008: Public Evacuation Decisions and Hurricane Track Uncertainty. *MANAGEMENT SCIENCE*, **54**, 16-28.